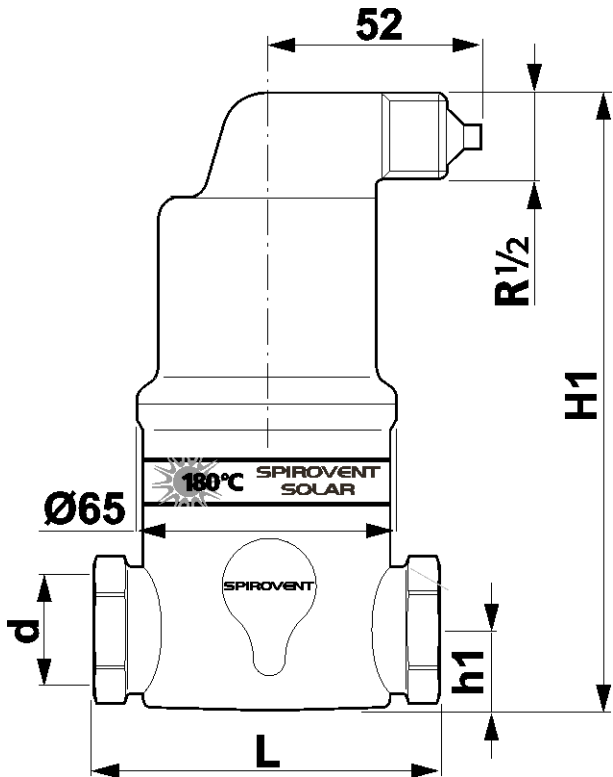

Typ: Separator mikropełcherzy powietrza SPIROVENT do kolektorów słonecznych

Numer katalogowy	AA150/008	
Materiał	Mosiądz	
Wydatek m ³ /h	5.00	
Średnica	1 1/2"	
Temperatura	180	
Ciśnienie	10	

H1 [mm]	234	h1 [mm]	42
L [mm]	88	Objętość [l]	0.32
Waga [kg]	1.60		