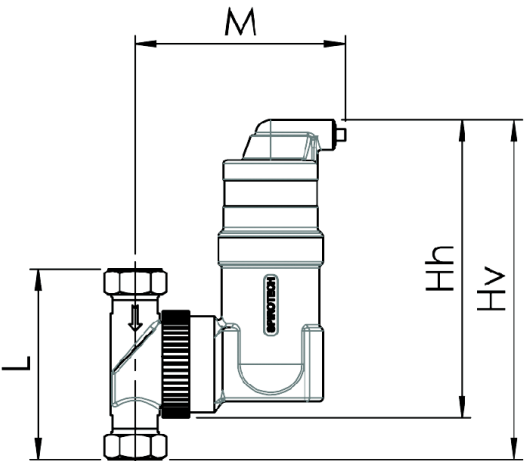

Typ: Separator mikropecherzy powietrza SPIROVENT RV2 - obrotowa
flansza

Numer katalogowy	UA028W	
Materiał	Mosiądz	
Wydatek m ³ /h	2.00	
Średnica	28 MM	
Temperatura	180	
Ciśnienie	6	

H1 [mm]	0	h1 [mm]	0
L [mm]	0	Objętość [l]	0.18
Waga [kg]	1.80		