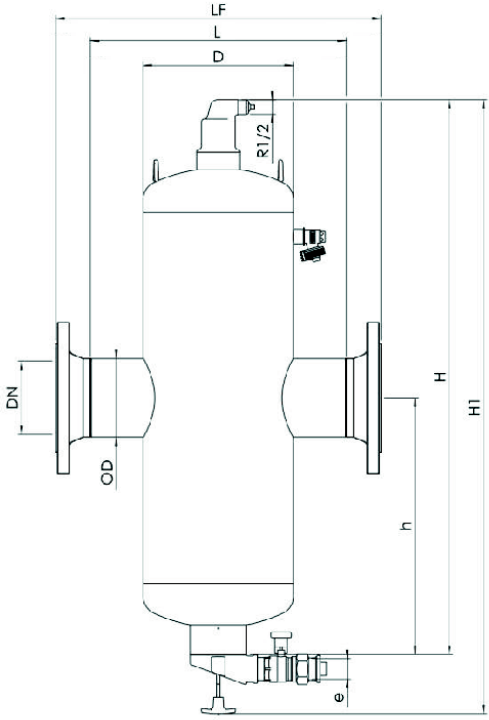

Typ: Separator mikropecherzy powietrza i zanieczyszczeń SPIROCOMBI
MAGNET (połączenie spawane)

Numer katalogowy	BC050LM	
Materiał	Stalowy z magnesem	
Wydatek m ³ /h	12.50	
Średnica	DN050	
Temperatura	110	
Ciśnienie	10	

OD [mm]	60.3	H1 [mm]	630
h [mm]	265	D [mm]	159
e	G1	L [mm]	260
Objętość [l]	7.00	przy Δp kPa	3.0
Waga [kg]	11.00	Waga z opakowaniem	12.00