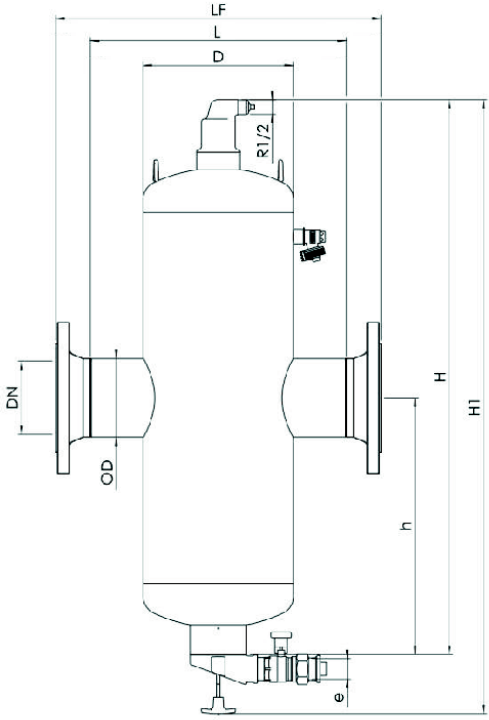

Typ: Separator mikropecherzy powietrza i zanieczyszczeń SPIROCOMBI MAGNET (połączenie spawane)

Numer katalogowy	BC080LM	
Materiał	Stalowy z magnesem	
Wydatek m ³ /h	27.00	
Średnica	DN080	
Temperatura	110	
Ciśnienie	10	

OD [mm]	88.9	H1 [mm]	765
h [mm]	345	D [mm]	219
e	G1	L [mm]	370
Objętość [l]	25.00	przy Δp kPa	3.1
Waga [kg]	23.00	Waga z opakowaniem	33.00